

300 STILE
S/A D300 FOR OFFSET PIVOT/BUTT HINGE

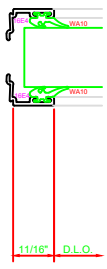

305 STILE
S/A D300 FOR OFFSET PIVOT/BUTT HINGE

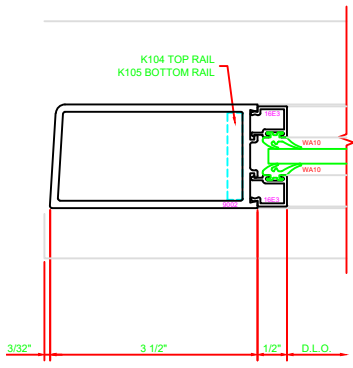
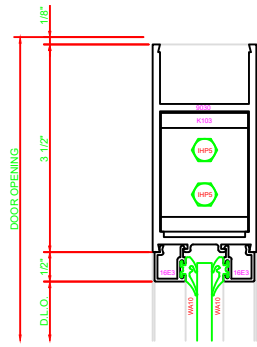
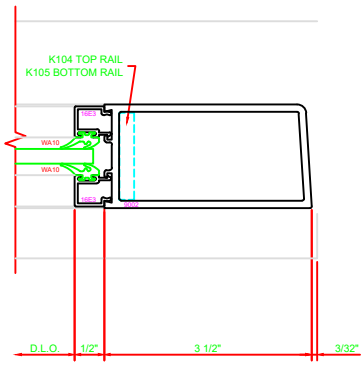

100 TOP RAIL
S/A D300

ERASE NOTE:
TOP RAIL FOR SURFACE CLOSERS OR DORMA TYPE C.O.C., NOT LCN C.O.C.

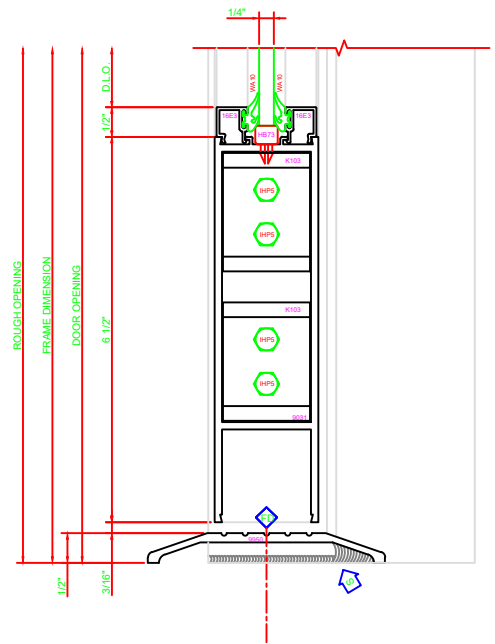
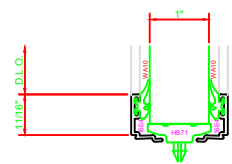
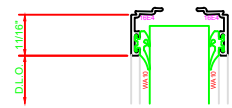

200 BOTTOM RAIL
S/A D300